

morphy richards®



Register online for your 2 year guarantee. See back of this instruction book for details.
(UK and Ireland customers only)
www.morphyrichards.co.uk



intellisteam™ Food Steamer

Please read and keep these instructions

Getting the best from your new appliance...

IntelliSteam brings the whole meal together at precisely the same time to make steaming as easy as 1, 2, 3.



PREPARE



SET & RELAX



ENJOY

Easy set-up guide

To get started quickly, see pages 3 and 4.

Recipes

For inspiration, see the weekly meal plan on page 14.



FS48781 MUK Rev 1

If you have a problem or complaint, please call our dedicated UK based helpline before returning your product to the retailer from where it was purchased.



UK Helpline: 0844 871 0951
Replacement Parts: 0844 873 0717
Ireland Helpline: 1800 409 119



For details of other Morphy Richards products, plus replacement parts and accessories, please see our website:

www.morphyrichards.com



CONTENTS

EASY SET-UP GUIDE	3-4
FEATURES	5
BEFORE USE	6
USING	6
CONFIGURATIONS	6-7
DIGITAL INTERFACE	7-8
HINTS AND TIPS	9
COOKING GUIDE	10-13
CARE AND CLEANING	13
RECIPES	14-21
IMPORTANT SAFETY INSTRUCTIONS	22
ELECTRICAL REQUIREMENTS	23
HELPLINE	23
GUARANTEE	24



intellisteam™

Easy set-up guide

Please also refer to the main instruction booklet, which contains important safety information and more detail on how to use Intellisteam.

1

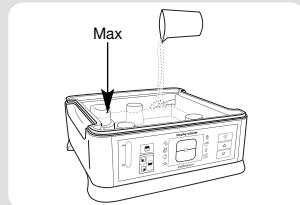

Fill the water reservoir with cold water to the maximum level. This will produce enough steam to cook for approximately 60 minutes.

2



Assemble the appliance, fitting the drip tray and then the containers.

3

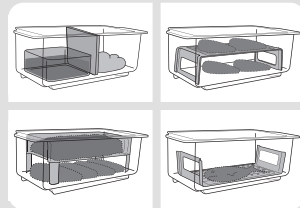

Place food directly into the containers before setting the timer. Use the divider wall for the front container if cooking two different types of food. Use the accessories if required, see suggestions.

4

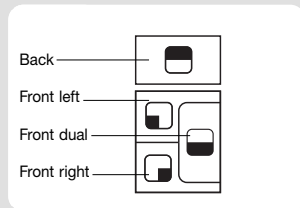

Plug into the electrical socket. Set the time for each container, using the corresponding heater buttons.

5

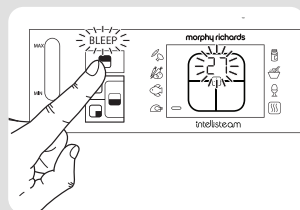

Press the heater button until the food type you wish to select for that compartment is selected and the corresponding time automatically appears on the screen.

- Leaf/pod veg, 15 mins
- Root veg, 35 mins
- Fish, 20 mins
- Chicken, 27 mins
- Sauce, 30 mins
- Rice, 42 mins
- Soft boiled eggs, 16 mins

6

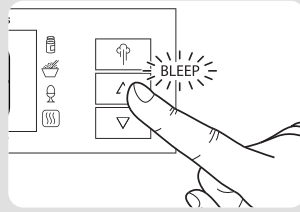

The pre-set cook time is based on cooking four portions (see 'Cooking guide' for portion and specific food type adjustments). To adjust the time, press the upwards and downwards arrows.

7

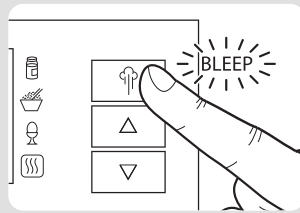

To begin cooking, press the steam button once. One bleep will sound.

To save adjusted times for future use, hold the steam button down for two seconds, until a second bleep is heard.

8

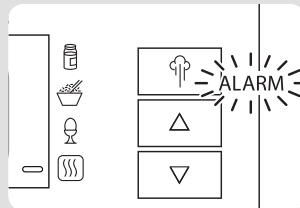

The container with the longest cook time will begin steaming first. The timer counts down so all food finishes together. After cooking has finished, the alarm will sound and the keep warm function will start automatically for 40 minutes. To stop the keep warm function, press the steam button.

9

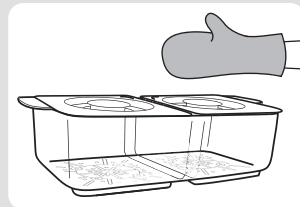

WARNING: Use oven gloves to remove the lids and containers, ensuring the lids are tilted to direct the steam away from you. Do not remove the drip tray until it is completely cooled.

10

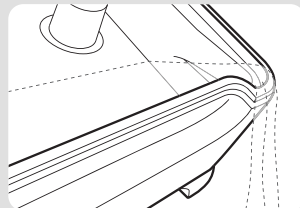

Pour away excess water from the main base unit, using the pouring lip at the back.

The containers, lids, accessories and drip tray may be washed in a dishwasher.

Features

- 1 Back lid
- 2 Back container
- 3 Front left lid
- 4 Front right lid
- 5 Front container removable divider wall
- 6 Front container
- 7 External water top-up
- 8 Drip tray
- 9 Main base unit / water reservoir
- 10 Maximum water level indicator
- 11 Heaters
- 12 Pouring lip
- 13 Water level gauge
- 14 Back heater button
- 15 Front left heater button
- 16 Front right heater button
- 17 Front dual heater button
- 18 Display screen (see page 7)
- 19-23 See display diagram on page 7
- 24 Steam button
- 25 Increase steam time button
- 26 Decrease steam time button

Accessories

- 27 Food plinth
- 28 2 x sauce trays
- 29 Rice tray

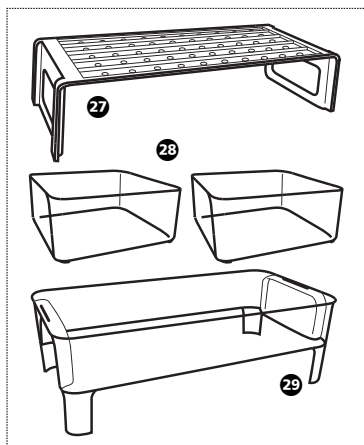
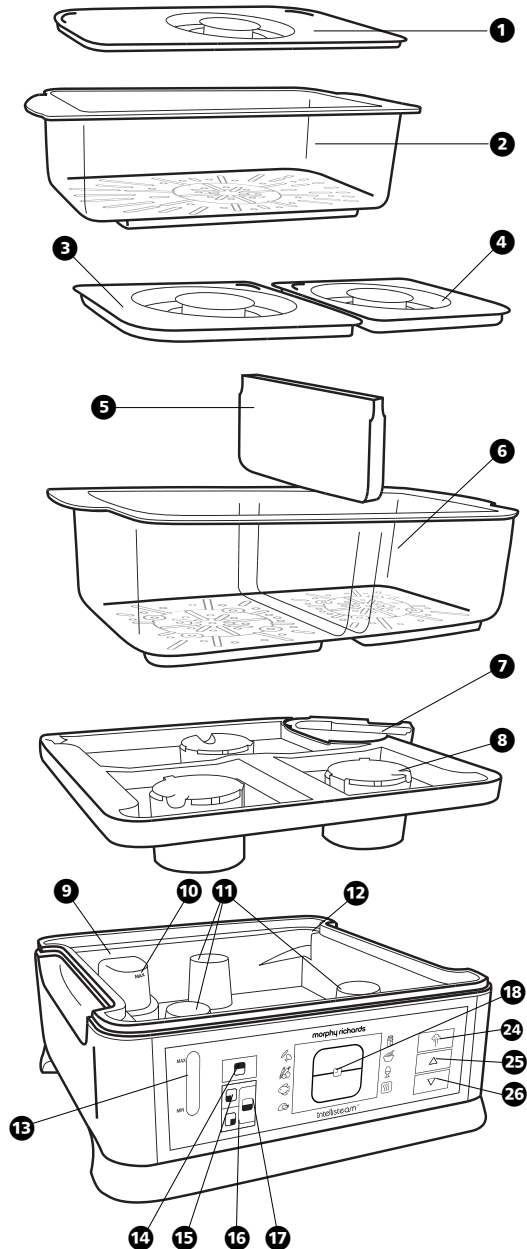

For details of other Morphy Richards products, please see our website: www.morphyrichards.com

BEFORE USE

Before using Intellisteam for the first time, wash all parts except the main base unit ⑨.

USING

Filling the water reservoir A

- Fill the water reservoir ⑨ with cold water to the maximum level indicated ⑩. This will produce enough steam to cook for approximately 60 minutes.
- The system is designed for cold water only. Do not add any other liquids or add anything to the water.

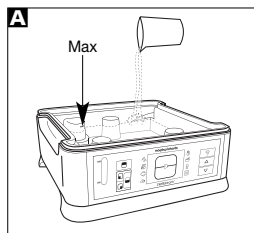

Fitting the drip tray and containers B

- 1 Fit the drip tray ③ to the main base, aligning the steam vents with the heaters ⑪.
- 2 Fit the front ⑥ and back ② containers to the drip tray, aligning them above the steam vents in the drip tray.

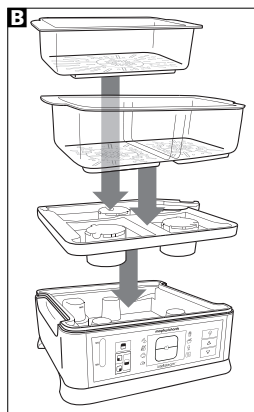

USING THE ACCESSORIES TO ARRANGE YOUR FOOD BEFORE COOKING

- Place food directly into the containers or use accessories as required. The accessories are very versatile and can be used in a number of ways (see diagrams C, D, E, F, G).

Front container removable divider wall

- Use the divider wall ⑤ if cooking foods with different cook times. Alternatively, use the front container as one large container C.

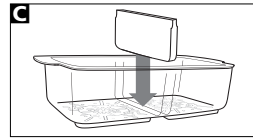

Food plinth

- Use in the front or back container.
- Use the plinth ⑦ in raised position to place food on and below D.

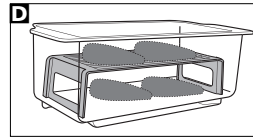

- Alternatively, use the plinth upside down to place food on, using the legs as handles for easy removal E.

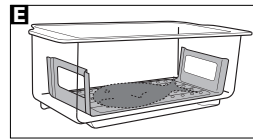

Rice Tray

- Use in the front or back container.
- Use for cooking rice or pasta. Other foods may be cooked in the space below the rice tray F.

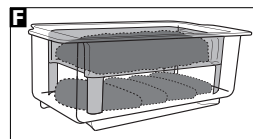

Sauce Trays

- Use in the front or back container.
- Use for cooking sauce, peas or small portions of rice G.

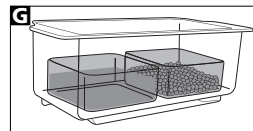

- **IMPORTANT: If steaming meat, fish or poultry together with vegetables, always place the meat, fish or poultry separately so that the juices from raw or partially cooked meat cannot drip onto other foods.**
- Once food is arranged, place all lids 1 3 4 back on the containers H.

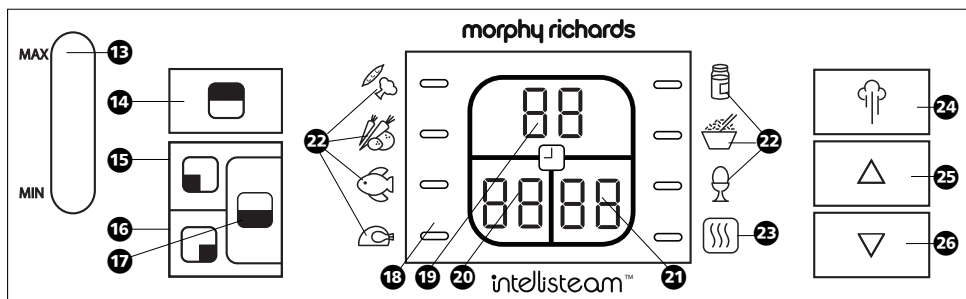
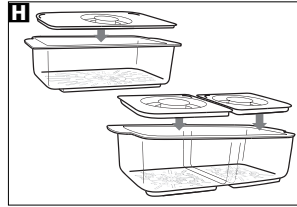

Display screen features

- 13 Water level gauge
- 14 Back heater button
- 15 Front left heater button
- 16 Front right heater button
- 17 Front dual heater button
- 18 Display screen
- 19 Time selected for back compartment
- 20 Time selected for front left compartment
- 21 Time selected for front right compartment
- 22 Food symbols
- 23 Keep warm symbol
- 24 Steam button
- 25 Increase steam time button
- 26 Decrease steam time button

Setting timer using pre-set cook times

- 1 Plug into the electrical socket.
- 2 Set the time for each container using the corresponding heater buttons. If using the front container with the divider wall, use the separate right and left heater buttons.

If using as one large container, use the dual heater button II.

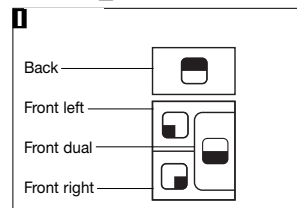

- 3 Press the heater button for the compartment you wish to programme (14 15 16 17) until it appears under the required food symbol (refer to food symbols guide 22). A bleep will sound each time the heater button is pressed. The cook time for each food symbol will appear on the screen. Repeat this process for each container, the time and dash next to the selected food type will flash to indicate your last setting I.

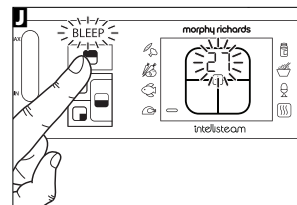

- If using the back container for foods with different cook times, set the timer to the longest cook time. Alternatively, stop the appliance during cooking and add the food with the shortest cook time.

- 4 Press the steam button **24** once to begin cooking. A bleep will sound and cooking will begin. The timer will count down from the longest cook time so everything finishes together **K**.

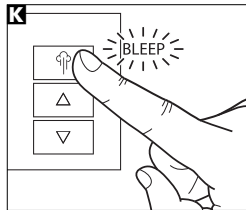

- When cooking has finished, the alarm will sound and the keep warm function will start automatically for 40 minutes. To stop, press the steam button once. After 40 minutes, the keep warm function will automatically turn off **L**. Always check there is water in the water reservoir when using the keep warm function.

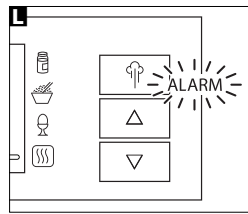



Food symbols guide **2**

 **Leaf & Pod vegetables,**
pre-set time: 15 minutes

 **Root vegetables,**
pre-set time: 35 minutes

 **Fish,**
pre-set time: 20 minutes

 **Chicken,**
pre-set time: 27 minutes

 **Sauce,**
pre-set time: 30 minutes

 **Rice,**
pre-set time: 42 minutes

 **Soft boiled eggs,**
pre-set time: 16 minutes

 **Keep warm **23**,**
pre-set time: 40 minutes

Pre-set times are a guide and based on approximately 4 portions. Refer to 'Cooking guide' for portion and specific food type adjustments.

Adjusting the timer

The timer can be adjusted for portion sizes and specific food types (see cooking guide) or to suit your personal preferences.

- Press the heater button until the dash appears next to the food symbol you want to adjust.
- Press the upwards arrow button to increase the cook time or the downwards arrow button to decrease the cook time. Each time the arrow button is pressed, a bleep will sound and the time will increase/decrease by one minute **M**.

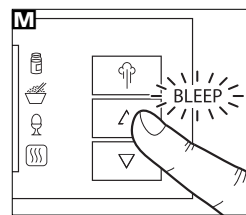

- Repeat the process for each container as required.

Saving time adjustments

To save your personal time adjustments for future use, hold down the steam button for two seconds. One bleep will sound, indicating steaming has begun, the second bleep indicates your time adjustments have been saved **N**.

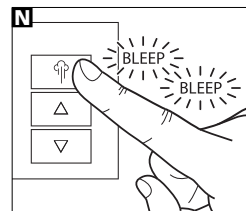

- If you do not want to save your personal time settings for future use, press the steam button once to start cooking.

Reverting back to pre-set times

- 1 Plug into the electrical socket.
- 2 Before pressing any other buttons, hold down the increase steam time button for 2 seconds until a bleep is heard. Repeat for the decrease steam time button **Q**.

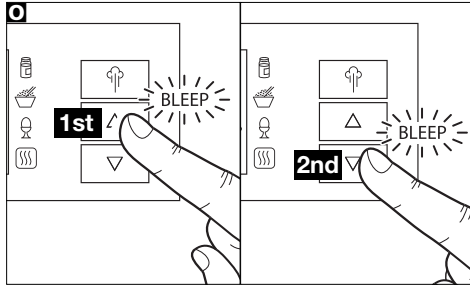

- Intellisteam is now set to the original pre-sets.

To cook rice

- 1 Add rice to the rice tray. For every 75g of rice, add 122ml of cold water and stir.
- 2 Set the time using the pre-set time for rice or adjust if required.

To stop steaming during cooking

- To stop steaming, press the steam button once, the alarm will sound.
- To re-start steaming, press the steam button once. A bleep will sound and cooking will start from when it stopped.

Keep warm function

When cooking has finished, the alarm will sound and the keep warm function will start automatically for 40 minutes. To stop, press the steam button once. After 40 minutes the keep warm function will automatically turn off. Whilst Intellisteam is in keep warm mode, the indicator light will appear underneath the keep warm symbol on the screen.

Always check there is water in the water reservoir when using the keep warm function. To check the water level, use the external water gauge **7** and fill using the external water top-up **P**.

External water top-up during cooking

- If steaming for a long period, it may be necessary to add extra water. The water level can be checked using the external water gauge.
- To fill, fully extend the external water top-up **7** and slowly pour cold water through it using a suitable jug **P**.

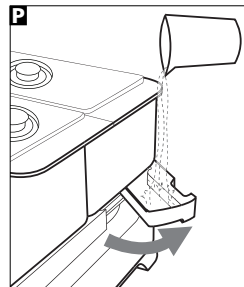

Boil dry alarm

- If water in the water reservoir reaches unsafe levels, an alarm will sound, the digital display will flash, and cooking will stop automatically.

Immediately add more cold water by slowly pouring through the external water top-up.

To restart cooking, press the steam button once. Cooking will re-start from when it stopped.

Removing food from the steamer

- **WARNING: Use oven gloves to remove the lids and containers, ensuring the lids are tilted to direct the steam away from you. Do not remove the drip tray until it is completely cooled.**

COOKING HINTS AND TIPS

- For best results, use pieces of food that are similar in size. If pieces vary in size and layering is required, place smaller pieces on top.
- Do not crowd food in the containers or rice tray. Arrange the food with spaces between pieces to allow for maximum steam flow.
- Never steam meat, poultry or seafood from frozen. Always completely thaw first.
- Meat, poultry and seafood can be wrapped and cooked in cooking foil to retain juices.





COOKING GUIDE

Cooking times are approximate and may vary depending on the size of the food, the space between the food, and the amount of food. Portion sizes per person are a guide only.







Meat / Poultry (pre-set time: 27 mins)

Protein from meat and poultry may leave white residue on meat and poultry when cooked.

Food type	1 portion 	2 portions 	3 portions 	4 portions 
Chicken breast (whole boneless)	18 mins x1 (150g / 6oz)	20 mins x2 (300g / 11oz)	25 mins x3 (450g / 16oz)	27 mins x4 (600g / 21oz)
Duck breast (whole boneless)	18 mins x1 (150g / 6oz)	20 mins x2 (300g / 11oz)	25 mins x3 (450g / 16oz)	27 mins x4 (600g / 21oz)
Chicken drumsticks	20 mins	20 mins	30 mins	30 mins
Turkey escalope	11 mins x1 (100g / 4oz)	15 mins x2 (200g / 7oz)	20-25 mins x3 (300g / 10oz)	20-25 mins x4 (400g / 14oz)
Pork fillet	20 mins 80g / 3oz	20 mins 160g / 6oz	25 mins 250g / 9oz	30 mins 400g / 14oz
Lamb steaks	20 mins x1 (100g / 4oz)	20 mins x2 (200g / 7oz)	23 mins x3 (300g / 10oz)	23-27 mins x4 (400g / 14oz)
Lamb leg	20 mins x1 (100g / 4oz)	20 mins x2 (200g / 7oz)	25 mins x3 (300g / 10oz)	25-30 mins x4 (400g / 14oz)
Lamb rump steaks	20 mins x1 (100g / 4oz)	20 mins x2 (200g / 7oz)	25 mins x3 (300g / 10oz)	25-30 mins x4 (400g / 14oz)
Sausages	15 mins x3 (170g / 6oz)	15 mins x6 (340g / 12oz)	17 mins x9 (500g / 18oz)	22-30 mins x12 (680g / 24oz)



Fish / Shellfish (pre-set time: 20 mins)

Food type	1 portion 	2 portions 	3 portions 	4 portions 
Thick fillet of fish	15 mins 125g / 5oz	15 mins 250g / 9oz	20 mins 375g / 13oz	20 mins 500g / 18oz
Thin fillet of fish	13 mins 100g / 4oz	13 mins 200g / 7oz	15 mins 300g / 10oz	16 mins 400g / 14oz
Whole fish	23 mins for 1 whole fish (220g / 8oz)			
Mussels	10 mins 200g / 7oz	10-12 mins 400g / 14oz	12-13 mins 600g / 21oz	15-17 mins 800g / 28oz
King prawns (raw)	10 mins 100g / 4oz	13 mins 200g / 7oz	15 mins 300g / 10oz	15-17 mins 400g / 14oz
Scallops	10 mins x3 (70g / 3oz)	10 mins x6 (150g / 5oz)	12 mins x9 (230g / 8oz)	13 mins x12 (300g / 10oz)

Leaf and Pod Vegetables (pre-set time: 15 mins)

Food type	1 portion 	2 portions 	3 portions 	4 portions 
Asparagus	15 mins 60g / 2oz	12-15 mins 120g / 5oz	15 mins 180g / 6oz	15-17 mins 240g / 8oz
Broad beans	15 mins 50g / 2oz	15 mins 100g / 4oz	20 mins 150g / 6oz	20 mins 200g / 7oz
Broccoli	20 mins 60g / 2oz	20 mins 120g / 5oz	22-25 mins 180g / 6oz	25-27 mins 240g / 8oz
Cabbage	15 mins 50g / 2oz	15 mins 100g / 4oz	15-20 mins 150g / 6oz	20 mins 200g / 7oz
Cauliflower florets	30 mins 100g / 4oz	30 mins 200g / 7oz	30 mins 300g / 10oz	30 mins 400g / 14oz
Courgette	15 mins 60g / 2oz	15 mins 120g / 5oz	15 mins 180g / 6oz	15 mins 240g / 8oz
Green beans	20 mins 50g / 2oz	20 mins 100g / 4oz	20-23 mins 150g / 6oz	25 mins 200g / 7oz
Leeks	15 mins 70g / 3oz	15 mins 140g / 6oz	15 mins 210g / 7oz	15-17 mins 280g / 9oz
Mange tout	12-15 mins 50g / 2oz	12-15 mins 100g / 4oz	15 mins 150g / 6oz	15 mins 200g / 7oz
Mushrooms	13-15 mins 50g / 2oz	13-15 mins 100g / 4oz	13-15 mins 150g / 6oz	15 mins 200g / 7oz
Peas (fresh)	10 mins 60g / 2oz	10 mins 120g / 5oz	10 mins 180g / 6oz	10-12 mins 240g / 8oz
Peas (frozen)	10 mins 60g / 2oz	10 mins 120g / 4oz	10 mins 180g / 6oz	10-12 mins 240g / 8oz
Peppers	15 mins 80g / 3oz	15 mins 160g / 6oz	15 mins 240g / 8oz	15-17 mins 320g / 10oz
Spinach	15 mins 60g / 2oz	15 mins 120g / 5oz	15 mins 180g / 7oz	15 mins 240g / 8oz
Sprouts	20 mins 100g / 4oz	20 mins 200g / 7oz	25 mins 300g / 10oz	25-30 mins 400g / 14oz
Sweet corn (canned)	12-13 mins 80g / 3oz	15 mins 160g / 6oz	17 mins 240g / 8oz	18-20 mins 320g / 10oz
Sweet corn (frozen)	15 mins 80g / 3oz	15 mins 160g / 6oz	17 mins 240g / 8oz	18-20 mins 320g / 10oz
Tomatoes	10 mins 120g / 5oz	10-15 mins 240g / 8oz	15 mins 360g / 13oz	15 mins 400g / 14oz

For details of other Morphy Richards products, please see our website: www.morphyrichards.com



Root vegetables (pre-set time: 35 mins)





Food type	1 portion 	2 portions 	3 portions 	4 portions
Butternut squash	15 mins 100g / 4oz	15 mins 200g / 7oz	20 mins 300g / 10oz	20-25 mins 400g / 14oz
Carrots	30 mins 100g / 4oz	30 mins 200g / 7oz	30 mins 300g / 10oz	30 mins 400g / 14oz
Celeriac	20 mins 100g / 4oz	20 mins 200g / 7oz	20 mins 300g / 10oz	20 mins 400g / 14oz
New potatoes	28 mins 180g / 6oz	30 mins 350g / 12oz	32 mins 530g / 19oz	35 mins 760g / 27oz
Old potatoes	30 mins 180g / 6oz	30 mins 350g / 12oz	32 mins 530g / 19oz	33-35 mins 760g / 27oz
Onions (small whole)	20 mins x2	20 mins x4	20 mins x6	20 mins x8
Swede	30 mins 100g / 4oz	30-32 mins 200g / 7oz	35 mins 300g / 10oz	35-40 mins 400g / 14oz
Sweet corn (whole cobs)	30 mins for 1 whole cob (250g / 9oz)		30 mins for 2 whole cobs (500g / 18oz)	







Rice / Pasta / Noodles (pre-set time: 42 mins)

Food type	1 portion 	2 portions 	3 portions 	4 portions 	Hints and Tips
Easy cook rice	30 mins 75g / 3oz	30 mins 150g / 6oz	35 mins 225g / 8oz	42 mins 300g / 10oz	Add 112ml of cold water per 75g portion of rice, and stir.
White long grain rice	30 mins 75g / 3oz	30 mins 150g / 6oz	40 mins 225g / 8oz	40 mins 300g / 10oz	Add 112ml of cold water per 75g portion of rice, and stir.
White basmati rice	30 mins 75g / 3oz	30 mins 150g / 6oz	35 mins 225g / 8oz	45 mins 300g / 10oz	Add 112ml of cold water per 75g portion of rice, and stir.
Bulgar wheat	20 mins 75g / 3oz	27 mins 150g / 6oz	30 mins 225g / 8oz	30 mins 300g / 10oz	Add 100ml of water per portion
Couscous	15 mins 75g / 3oz	17 mins 150g / 6oz	20 mins 225g / 8oz	25 mins 300g / 10oz	Add 65ml of water per portion
Ready-to-Wok Noodles	10 mins 1 pack (125g / 5oz)	10 mins 2 packs (250g / 9oz)	10-15 mins 3 packs (375g / 13oz)	10-15 mins 4 packs (500g / 18oz)	Add 1 tbsp of cold water per portion, and stir
Egg noodles	20 mins 1 sheet (60g / 2oz)	20 mins 2 sheets (120g / 5oz)	27 mins 3 sheets (180g / 7oz)	27 mins 4 sheets (240g / 8oz)	Make sure water covers noodles
Pasta	30 mins 75g / 3oz	35 mins 150g / 6oz	Too large to fit in the rice container	Too large to fit in the rice container	Make sure water covers pasta

**Eggs** (pre-set time: 16 mins)

Food type	1 portion 	2 portions 	3 portions 	4 portions 
Soft boiled	11 mins x1	12 mins x2	14 mins x3	16 mins x4
Hard boiled	18 mins x1	20 mins x2	22 mins x3	23-24 mins x4

Fruit

Food type	1 portion 	2 portions 	3 portions 	4 portions 
Pears	20 mins x1	20-25 mins x2	25 mins x3	22-30 mins x4
Bananas (in skin)	15 mins x1	20 mins x2	25 mins x3	30 mins x4
Apples	15 mins x1	15-17 mins x2	15-17 mins x3	15-17 mins x4

CARE AND CLEANING

WARNING: Allow steamer to cool before washing. Unplug from the mains socket.

- Remove the containers and the lids.
- Carefully remove the drip tray and pour away juices into a bowl or sink.
- If there is any water remaining in the main base unit, pour away using the pouring lip at the back into a bowl or sink.

Containers, drip tray and accessories

The containers, lids, accessories and drip tray may be washed in a dishwasher. Prolonged dishwasher use could discolour these parts. Alternatively, wash in hot soapy water, rinse and dry thoroughly.

Main base unit

The base unit may be wiped with a clean, damp cloth. Wipe dry with a soft cloth.

Do not use abrasive cleaners to clean any part of Intellisteam.

WARNING: Do not immerse the steamer base, cord or plug in water or in any other liquid.

DESCALING

Occasionally, you may need to remove mineral deposits (known as descaling) from the steaming system. This is normal and will depend on the degree of hardness of the water in your area. If you notice a slowing in steam production, or a lengthening of steaming times, you should descale the steaming system using a mild descaling solution.

RECIPES

Enjoy our delicious weekly recipe plan. Visit our website for recipes and more information about Intellisteam.

MONDAY

Sesame Salmon Noodles and Steamed Greens with Coconut Milk and Sweet Chilli Sauce

Preparation time: 15 minutes

Cooking time: 20 minutes

Serves: 4

Ingredients:

- 4 x 125g (5oz) salmon fillets
- 4 tsp toasted sesame oil
- 1 tsp sesame seeds
- 2 x 150g packs of medium or thick ready-to-wok noodles
- 4 tbsp hot vegetable stock

Vegetables:

- 150g (6oz) sugar snap peas or mangetout, halved
- 6 spring onions, thinly sliced
- 1 carrot, cut into fine strips

Sauce:

- 300ml (1/2 pint) coconut milk
- 2 tbsp sweet chilli sauce
- 1 tsp grated fresh root ginger
- 1 tbsp chopped fresh coriander

Method:

- 1 Brush salmon fillets with sesame oil and then sprinkle with sesame seeds. Arrange in the back container. Empty 2 packs of noodles into the rice tray and position above the salmon. Add vegetable stock to the noodles.
- 2 Position the divider wall in the front container. Mix the vegetables together and put into the compartment.
- 3 Pour coconut milk into the sauce tray and stir in sweet chilli sauce, ginger and coriander. Place the tray in the remaining compartment.
- 4 Set time for the salmon and noodles using the fish pre-set (20 mins). Set time for the sauce using the sauce pre-set (30 mins) then adjust to 18 mins. Set time for the vegetables using the leaf and pod vegetable pre-set (15 mins).

Cooks tip:

- Stir noodles before serving.
- If you prefer crunchier vegetables, adjust the pre-set time.
- Fish can be wrapped and cooked in cooking foil to retain juices and prevent surface protein.



TUESDAY**Maple-glazed Chicken with
Corn-on-the-cob and Crushed
Butternut Squash**

Preparation time: 15 minutes,
plus marinating

Cooking time: 35 minutes

Serves: 4

Ingredients:

- 4 skinless, boneless chicken breasts
- Finely grated zest and juice of 1 small orange
- 2 tbsp maple syrup
- 1/4 tsp dried chilli flakes
- Salt and freshly ground black pepper

Rice:

- 250g (9oz) white and wild rice
- 1 tsp vegetable stock powder

Vegetables:

- 2 corn-on-the-cob, cut in half
- 1 medium butternut squash, peeled, deseeded and cut into chunks
- 15g (1/2 oz) butter
- 2 tsp finely chopped fresh rosemary

Method:

- 1 Put chicken breasts into a non-metallic bowl and add orange zest, orange juice, maple syrup and chilli flakes. Season with a little salt and plenty of black pepper. Cover and refrigerate for at least 30 minutes.
- 2 Arrange the chicken breasts in the back container. Put rice and vegetable stock powder into the rice tray. Position the rice tray above the chicken and add 250ml (9fl oz) of cold water to the rice, stirring to mix.
- 3 Position the divider wall in the front container. Put four pieces of corn-on-the-cob in one compartment and the butternut squash in the remaining compartment.
- 4 Set time for the chicken and rice using the chicken pre-set (27 mins) then adjust to 35 minutes. Set time for the corn-on-the-cob using the root vegetable pre-set (35 mins) then adjust to 30 minutes. Set time for butternut squash using the root vegetable pre-set (35 mins) then adjust to 25 minutes.
- 5 When cooked, add butter and rosemary to butternut squash and crush lightly with a fork.

Cooks tip:

- Chicken can be wrapped and cooked in cooking foil to retain juices and prevent surface protein.



WEDNESDAY**Sweet Red Peppers stuffed with Leeks and Feta Cheese with Spring Onions and Pine Nut Couscous****Preparation time:** 25 minutes**Cooking time:** 25 minutes**Serves:** 4**Ingredients:**

- 4 sweet (long) red peppers, tops removed
- 1 small leek, finely chopped
- 1 tbsp chopped fresh parsley
- 2 tbsp olive oil
- 25g (1oz) finely grated parmesan cheese
- 25g (1oz) fresh bread crumbs
- 100g (4oz) feta cheese, finely crumbled
- Salt and freshly ground black pepper

Couscous:

- 200g (7oz) couscous
- 2 tsp vegetable stock powder
- 4 spring onions, finely chopped
- 25g (1oz) pine nuts

To garnish:

- Parsley sprigs

Method:

- 1 Split peppers lengthways, taking care not to cut in half. Remove the core and seeds. Mix together leek, parsley and olive oil, then add parmesan cheese and bread crumbs. Mix in crumbled feta cheese, then season with a little salt and plenty of black pepper. Stuff the mixture into the peppers.
- 2 Remove the divider wall from the front container and place the peppers inside.
- 3 Position the rice tray in the back container. Add couscous and 265ml of cold water. Stir in stock powder, spring onions and pine nuts.
- 4 Set time for couscous using the rice pre-set (42 mins) then adjust to 25 minutes. Set time for the peppers (using the front dual heater button) using the leaf and pod vegetable pre-set (15 mins) then adjust to 20 minutes.
- 5 When cooked, allow to stand for 5 minutes. Fluff up the couscous with a fork. Garnish with parsley sprigs.



THURSDAY***Tikka Masala Chicken with Zesty Cardamom Rice***

Preparation time: 10 minutes,
plus marinating

Cooking time: 42 minutes

Serves: 4

Ingredients:

- 4 tbsp low fat natural yogurt
- 2 tbsp chicken tikka masala curry paste
- 2 tbsp chopped fresh coriander
- 4 skinless, boneless chicken breasts, chopped into chunks
- Salt and freshly ground black pepper

Rice:

- 300g (11oz) basmati rice
- 2 tsp vegetable stock powder
- 2 strips pared lemon zest
- 6 green cardamom pods, lightly crushed

To garnish:

- Lime wedges and coriander sprigs

Method:

- 1** Spoon yoghurt, curry paste and coriander into a large non metallic bowl. Mix well, add chicken chunks and stir to coat. Season with a little salt and pepper, then cover and refrigerate for at least 30 minutes.
- 2** Position the rice tray in the back container. Add rice and 450 ml (16 fl oz) of cold water. Stir in stock powder. Put strips of pared lemon zest on top and sprinkle in cardamom pods.
- 3** Remove the divider wall from the front container. Tip the chicken with it's marinade into the container and make sure the mixture is well spread out.
- 4** Set time for the rice using the rice pre-set (42 mins). Set time for the chicken (using the front dual heater button) using the chicken pre-set (27 mins).
- 5** Serve garnished with lime wedges and coriander sprigs.

Cooks tip:

- Chicken can be wrapped and cooked in cooking foil to retain juices and prevent marinade from staining containers.



FRIDAY**Steamed Halibut with Lemon & Thyme Dressing.****Preparation time:** 15 minutes**Cooking time:** 35 minutes**Serves:** 4**Ingredients:**

- 4 x 125g (5oz) halibut fillets, skinned (or use Pacific cod)
- 15g (1/2oz) butter
- 4 small thyme sprigs
- Salt and freshly ground black pepper

Vegetables:

- 750g (1lb 11oz) small new potatoes
- 2 leeks, thinly sliced
- 1 large carrot, sliced into fine strips
- 150g (6oz) fine green beans, trimmed and halved

Sauce:

- 50g (2oz) butter
- Finely grated zest and juice of 1 lemon
- 1 tbsp fresh thyme leaves

Method:

- 1 Arrange fish fillets in the back container. Place a small knob of butter on top of each one and arrange thyme sprigs on top. Season with a little salt and pepper.
- 2 Position the divider wall in the front container. Put potatoes into one compartment. Mix vegetables together and put in the remaining compartment.
- 3 For the sauce, put butter, lemon zest, lemon juice and thyme leaves into the rice tray and position above the fish.
- 4 Set time for the fish and sauce using the fish pre-set (20 mins). Set time for the potatoes using the root vegetables pre-set (35 mins). Set time for the vegetables using the leaf and pod vegetables pre-set (15 mins).

Cooks tip:

- If you prefer crunchier vegetables, adjust the pre-set time.
- Fish can be wrapped and cooked in cooking foil to retain juices and prevent surface protein.



SATURDAY***Hoisin Duck with Egg Noodles and Steamed Chinese-spiced Vegetables.***

Preparation time: 10 minutes,
plus marinating

Cooking time: 27 minutes

Serves: 4

Ingredients:

- 4 skinless duck breasts, thinly sliced
- 4 tbsp hoisin sauce

Noodles:

- 180g (3 sheets) medium egg noodles

Vegetables:

- 350g pack fresh stir-fry vegetables
- 2 heads pak choi, broken into separate leaves
- 1 tbsp toasted sesame oil
- Pinch of Chinese 5-spice powder
- 1 tsp sesame seeds

To garnish:

- 4 spring onions, thinly sliced

Method:

- 1 Toss sliced duck breasts in hoisin sauce. Cover and refrigerate for at least 30 minutes.
- 2 Tip the duck breasts and any marinade into the back container. Position the rice tray above the duck and add noodles and 250 ml (9 fl oz) of cold water.
- 3 Remove the divider wall from front container. In a large bowl, toss the stir-fry vegetables, pak choi, toasted sesame oil and Chinese 5-spice powder together and tip into the front container.
- 4 Set time for the duck and noodles using the chicken pre-set (27 mins). Set time for the vegetables (using the front dual heater button) using the leaf and pod vegetable pre-set (15 mins).
- 5 Serve sprinkled with sesame seeds and garnish with spring onions.

Cooks tip:

- Stir noodles before serving.
- Duck can be wrapped and cooked in cooking foil to retain juices and prevent surface protein.



SUNDAY**Lamb with Oregano and
Tomato with Mint & Lemon
Baby Potatoes****Preparation time:** 20 minutes,
plus marinating**Cooking time:** 35 minutes**Serves:** 4**Ingredients:**

- 4 x 110-125g (4-5oz) lamb leg or lamb rump steaks
- 1 tbsp olive oil
- 1 large garlic clove, crushed
- 2 tbsp tomato puree
- 1 tsp dried oregano
- Salt and freshly ground black pepper

Potatoes:

- 750g (1lb 11oz) baby new potatoes, scrubbed
- 1 tbsp olive oil
- 1 tsp finely grated lemon zest
- 2 mint sprigs

Carrots:

- 400g (14oz) carrots, sliced
- 1/2 tsp cumin seeds (optional)
- 10g (1/3 oz) butter

To garnish:

- Mint sprigs

Method:

- 1 Put lamb steaks into a non metallic bowl and add the olive oil, garlic, tomato puree and oregano. Season with salt and pepper, then toss to coat. Cover and refrigerate for at least 30 minutes.
- 2 Put the lamb steaks in the back container.
- 3 Position the divider wall in the front container. Toss potatoes in olive oil and lemon zest, then tip the compartment and add mint sprigs. Place carrots in remaining compartment, sprinkle with cumin seeds (if using) and put butter on top.
- 4 Set time for the lamb using the chicken pre-set (27 mins). Set time for the carrots using the root vegetable pre-set (35 mins) then adjust to 30 minutes. Set time for the potatoes using the pre-set for root vegetables (35 mins).
- 5 Serve garnished with mint sprigs.

Cooks tip:

- Lamb can be wrapped and cooked in cooking foil to retain juices and prevent surface protein.



SUNDAY TREAT!**Ginger and Banana Sponge Pudding with Sticky Toffee Sauce****Preparation time:** 25 minutes**Cooking time:** 42 minutes**Serves:** 4**Ingredients:**

- 75g (3oz) butter, plus extra for greasing
- 75g (3oz) light muscovado sugar
- 2 medium eggs, beaten
- 1/2 tsp vanilla extract
- 75g (3oz) self-raising flour
- 1/2 tsp ground ginger
- Pinch of salt
- 1 large ripe banana, mashed
- 2 pieces stem ginger in syrup, plus 4 tbsp of syrup from the jar

Sauce:

- 3 tbsp golden syrup
- 25g (1oz) butter
- 25g (1oz) light muscovado sugar

To serve:

- Vanilla ice-cream or custard

Method:

- 1 In a large mixing bowl, cream butter and sugar until light and fluffy. Gradually beat in eggs, then stir in vanilla. Sift in flour, ground ginger and salt, and fold in, using a large metal spoon. Stir in the mashed banana.
- 2 Butter 2 x 200ml (7 fl oz) individual pudding basins. Slice stem ginger and place it in the bottom of the basins, spooning 1 tbsp of syrup into each one. Spoon over the creamed mixture and level the tops. Cover tightly with pieces of buttered foil.
- 3 Arrange the puddings in the back compartment.
- 4 Position the divider wall in the front container. Put the sauce ingredients into a sauce tray and place in one compartment.
- 5 Set time for the puddings using the rice pre-set (42 mins). Set time for the sauce using the sauce pre-set (30 mins) then adjust to 20 minutes.
- 6 When cooked, run a knife around the basins to release the puddings. Stir the sauce thoroughly and spoon over each pudding. Serve with ice-cream or custard.



IMPORTANT SAFETY INSTRUCTIONS

Personal safety

- Do not touch hot surfaces. Use oven gloves or a cloth when removing the lid or handling hot containers as hot steam will escape.
- **WARNING: To protect against fire, electric shock and personal injury, do not immerse cord, plugs, or appliance in water or other liquid.**
- **WARNING: Extreme caution must be used when moving the steamer when containing hot food, water, or other hot liquids.**
- Appliances must not be immersed.
- Unplug from the socket when not in use, before putting on or taking off attachments, and before cleaning.
- Do not operate any appliance with a damaged lead or plug, or after an appliance has malfunctioned, or has been dropped or damaged in any way. Contact Morphy Richards for advice on examination, repair or electrical or mechanical adjustment.
- Do not fill above the maximum level. If the steamer is over-filled, boiling water may be ejected which can scald.
- This appliance is not intended for use by persons (including children) with reduced physical, sensory or mental capabilities, or lack of experience and knowledge, unless they have been given supervision or instruction concerning the use of the appliance by a person responsible for their safety.

Location

- This appliance is intended to be used in household and similar applications such as:
 - farm houses;
 - by clients in hotels, motels and other residential type environments;
 - bed and breakfast type environments.
 It is not suitable for use in staff kitchen areas in shops, offices and other working environments.
- Do not use outdoors or near water.
- Ensure that this appliance is situated out of reach of children.

- Do not place directly under kitchen wall cupboards when in use, as it produces large amounts of steam. Avoid reaching over the steamer when in use.

Mains cable

- The mains cable should reach from the socket to the base unit without straining the connections.
- Do not let the cable hang over the edge of the table or counter and keep it away from any hot surfaces.
- Do not let the cable run across an open space e.g. between a low socket and table.
- If the supply cable is damaged, it must be replaced by the manufacturer, it's service agent or similarly qualified persons in order to avoid a hazard.

Children

- Never allow a child to operate this appliance. Teach children to be aware of dangers in the kitchen, warn them of the dangers of reaching up to areas where they cannot see properly or should not be reaching.
- Children should be supervised to ensure that they do not play with the appliance.

Other safety considerations

- Do not use attachments or tools not recommended by Morphy Richards as this may cause fire, electric shock or injury.
- To open, lift the lids off towards yourself but tilted away from you.
- Do not use any steamer parts in a microwave or on any cooking/heated surfaces.
- Do not place on or near a hot gas or electric burner, or in a heated oven.
- Do not leave it in a damp and corrosive environment.
- Do not switch the steamer on unless it contains at least 1 cup of water, otherwise the steamer may be damaged.
- Always make sure the water does not fall below the minimum level.

ELECTRICAL REQUIREMENTS

Check that the voltage on the rating plate of your appliance corresponds with your house electricity supply which must be A.C. (Alternating Current).

If the socket outlets in your home are not suitable for the plug supplied with this appliance, the plug should be removed and the appropriate one fitted.

WARNING: The plug removed from the mains cable, if severed, must be destroyed, as a plug with bared flexible cable is hazardous if engaged into a live socket outlet.

Should the fuse in the 13 amp plug require replacement, a 13 amp BS1362 fuse must be fitted.

WARNING: This appliance must be earthed.

HELPLINE

If you have any difficulty with your appliance, do not hesitate to call. We are more likely to be able to help than the store from where you bought it.

Please have the following information ready to enable our staff to deal with your enquiry quickly:

- Name of the product.
- Model number as shown on the underside of the appliance.
- Serial number as shown on underside of the appliance.

UK Helpline **0844 871 0951**

Replacement Parts **0844 873 0717**

Ireland Helpline **1800 409 119**

WEBSITE

You may also contact us through our website, or visit the site to browse and purchase appliances, spare parts and accessories from the extensive Morphy Richards range

www.morphyrichards.com



REGISTERING YOUR TWO YEAR GUARANTEE

Your standard one year guarantee is extended for an additional 12 months when you register the product within 28 days of purchase with Morphy Richards. If you do not register the product with Morphy Richards within 28 days, your product is guaranteed for 1 year. To validate your 2 year guarantee register with us online at www.morphyrichards.co.uk

N.B. Each qualifying product needs to be registered with Morphy Richards individually.

Please note that the 2 year guarantee is only available in the UK and Ireland. Please refer to the one year guarantee for more information.

YOUR ONE YEAR GUARANTEE

It is important to retain the retailer's receipt as proof of purchase. Staple your receipt to this back cover for future reference.

Please quote the following information if the product develops a fault. These numbers can be found on the base of the product.

Model no.

Serial no.

All Morphy Richards products are individually tested before leaving the factory. In the unlikely event of any appliance proving to be faulty within 28 days of purchase, it should be returned to the place of purchase for it to be replaced.

Morphy Richards products are intended for household use only. See usage limitations within the location safety instructions.

Morphy Richards has a policy of continuous improvement in product quality and design. The company, therefore reserves the right to change the specification of it's models at any time.

If the fault develops after 28 days and within 12 months of original purchase, you should contact the Helpline number quoting Model number and Serial number on the product, or write to Morphy Richards at the address shown.

You may be asked to return a copy of proof of purchase.

Subject to the exclusions set out below (see Exclusions), the faulty appliance will then be repaired or replaced and dispatched usually within 7 working days of receipt.

If, for any reason, this item is replaced during the 1 year guarantee period, the guarantee on the new item will be calculated from original purchase date. Therefore it is vital to retain your original till receipt or invoice to indicate the date of initial purchase.

To qualify for the 1 year guarantee, the appliance must have been used according to the instructions supplied. For example, crumb trays should have been emptied regularly.

EXCLUSIONS

Morphy Richards shall not be liable to replace or repair the goods under the terms of the guarantee where:

- 1 The fault has been caused or is attributable to accidental use, misuse, negligent use or used contrary to the manufacturer's recommendations or where the fault has been caused by power surges or damage caused in transit.
- 2 The appliance has been used on a voltage supply other than that stamped on the products.

- 3 Repairs have been attempted by persons other than our service staff (or authorised dealer).
 - 4 The appliance has been used for hire purposes or non domestic use.
 - 5 The appliance is second hand.
 - 6 Morphy Richards are not liable to carry out any type of servicing work, under the guarantee.
 - 7 Plastic filters for all Morphy Richards kettles and coffee makers are not covered by the guarantee.
 - 8 Batteries and damage from leakage are not covered by the guarantee.
- This guarantee does not confer any rights other than those expressly set out above and does not cover any claims for consequential loss or damage. This guarantee is offered as an additional benefit and does not affect your statutory rights as a consumer.



For electrical products sold within the European Community. At the end of the electrical products useful life, it should not be disposed of with household waste. Please recycle where facilities exist. Check with your Local Authority or retailer for recycling advice in your country.

morphy richards®

**The After Sales Division
Morphy Richards Ltd**
Mexborough, South Yorkshire,
England, S64 8AJ

Helplines (office hours)
UK 0844 871 0951
Spare Parts 0844 873 0717
Republic of Ireland 1800 409 119

FS48781 MUK Rev 1 12/09

For details of other Morphy Richards products, plus replacement parts and accessories, please see our website:

www.morphyrichards.com

